

C-Bow Taschenhalter

HONDA CBR 250 R
(2011-)

Art.-Nr.:
630966 00 01 schwarz

HONDA CBR 300 R

Art.-Nr.:
630991 00 01 schwarz



Montage

Der Bausatz umfasst die folgenden Teile:

Stück	Bestellnr.	Bezeichnung	Stück	Bestellnr.	Bezeichnung
2	700007063	C-Bow schwarz	4		Linsenkopfschraube M8x30
1	700008777	Halteadapter links	8		Sechskantschraube M6x16
1	700008778	Halteadapter rechts	2		Selbstsichernde Mutter M8
1	700008779	Halteadapter hinten	8		U-Scheibe Ø8,4
1	700008780	Schraubensatz, bestehend aus:	8		U-Scheibe Ø6,4
			2		Senkschrauben M8x110 (durchgehendes Gewinde)
2		Sechskantschrauben M8x45 (durchgehendes Gewinde)			



Anzugsmomente des Motorradherstellers beachten!
Nach der Montage alle Verschraubungen auf festen Sitz kontrollieren!
Bitte beachten Sie unsere beigefügten Serviceinformationen.



Hepco & Becker GmbH
An der Steinmauer 6
D-66955 Pirmasens
Tel.: 06331 - 1453 - 100
Fax: 06331 - 1453 - 120
eMail: vertrieb@hepco-becker.de
www.hepco-becker.de

C-Bow Taschenhalter

HONDA CBR 250 R
(2011-)

Art.-Nr.:
630966 00 01 schwarz

HONDA CBR 300 R

Art.-Nr.:
630991 00 01 schwarz



Montage

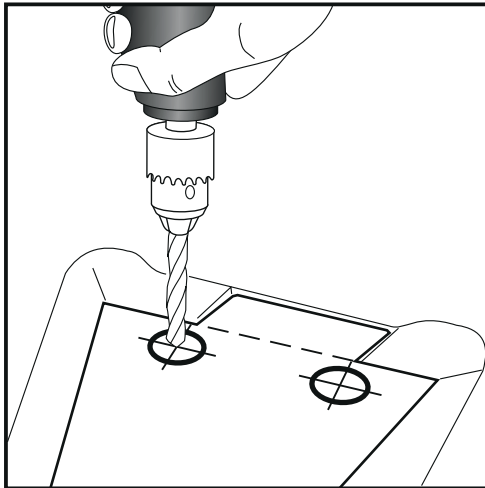

1

Vorbereitende Arbeiten:

Demontieren:

- Soziussitzbank
- Soziusfußrastenausleger lösen (Originalschrauben entfallen)
- Verkleidung Innenkotflügel demontieren und lt. Schablone aufbohren

Bohrung anbringen zur Montage des hinteren Halteadapters:

Bohrschablone ausschneiden und auf die Innenseite der Innenkotflügelverkleidung auflegen/aufkleben. An den vorgezeichneten Punkten eine runde Aussparung $\varnothing 25\text{mm}$ herstellen. Anschließend Innenkotflügelverkleidung wieder montieren.

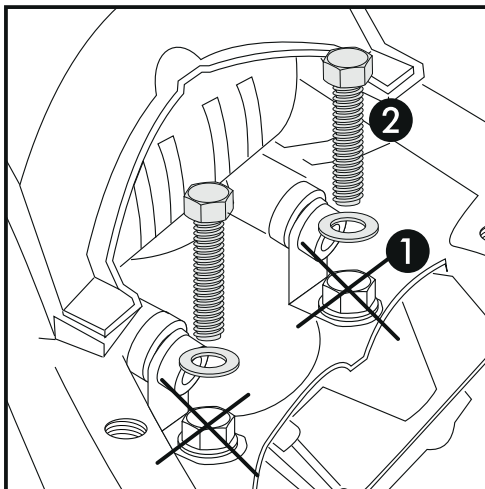

2

Befestigung des Halteadapters hinten:

Der Adapter verläuft quer unterhalb des Kotflügels. Die beiden hinteren Schrauben der Rahmenverschraubung ausdrehen (diese entfallen). Dazu vorher die Haltegriffe demontieren, um an die Verschraubung zu gelangen. Anstelle der Originalschrauben die Sechskantschrauben M8x45 mit U-Scheiben $\varnothing 8,4$ eindrehen und festziehen.

Bei zusätzlichem Anbau einer Gepäckbrücke müssen die Sechskantschrauben M8x45 durch die Senkschrauben M8x110 mit durchgängigem Gewinde ersetzt werden - siehe Anleitung Alurack.

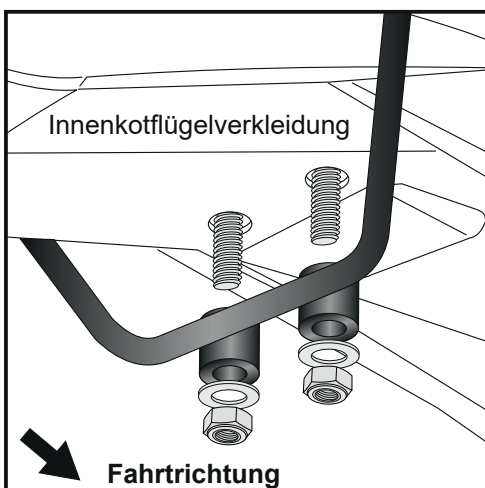
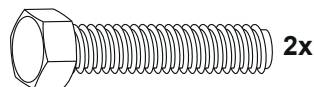

3

Befestigung des Halteadapters hinten:

An den nun überstehenden Gewinden der Sechskantschrauben M8x45 am Innenkotflügel (Bohrungen Abdeckung) den Adapter mit den selbstsichernden Muttern M8 sowie U-Scheiben $\varnothing 8,4$ befestigen. Noch nicht ganz festziehen. Haltegriffe montieren.



C-Bow Taschenhalter

HONDA CBR 250 R
(2011-)

Art.-Nr.:
630966 00 01 schwarz

HONDA CBR 300 R

Art.-Nr.:
630991 00 01 schwarz



Montage

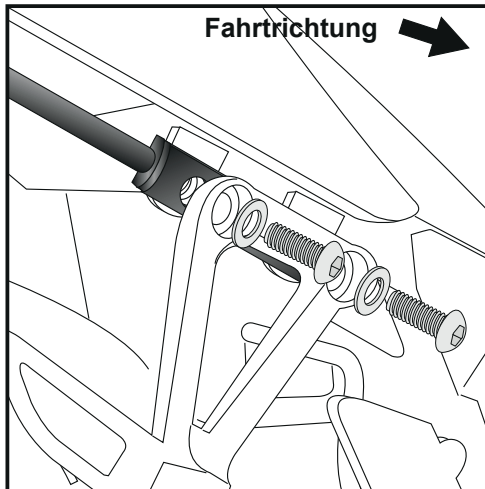

- 4** Befestigung der Halteadapter vorne links und rechts:
Die Halteadapter werden zwischen Rahmen und Fußrastenausleger mit den Linsenkopfschrauben M8x30 sowie U-Scheibe Ø8,4 montiert.
Schrauben noch nicht ganz festziehen.

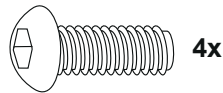

Montage C-Bow:

Zur Befestigung die Sechskantschrauben M6 x 16 mit U-Scheiben ø6,4 verwenden.

Nun alle Schrauben und Muttern festziehen.

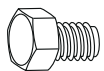

8x

8x

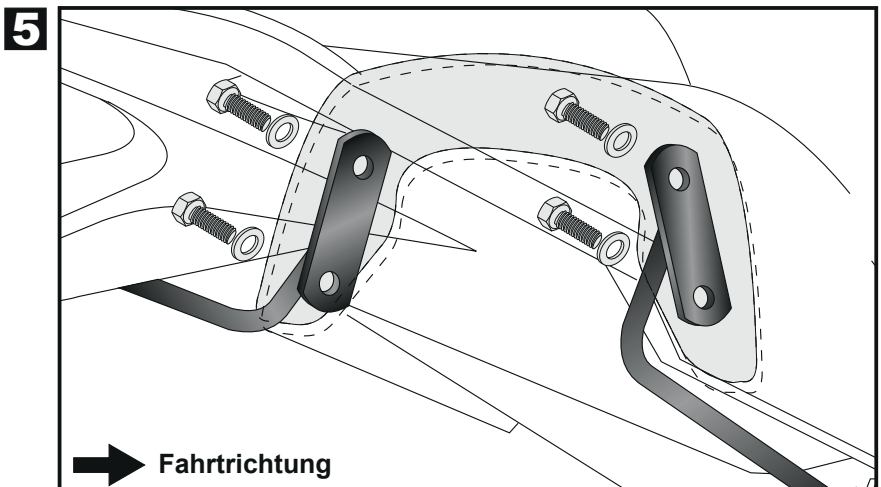

C-Bow Soft bag holder

HONDA CBR 250 R
(2011-)

Item-no.:
630966 00 01 black

HONDA CBR 300 R

Item-no.:
630991 00 01 black



Assembling instructions

The kit includes the following parts:

Quant	item no.	description
2	700007063	C-Bow black
1	700008777	adapter left
1	700008778	adapter right
1	700008779	rear adapter
1	700008780	Screw kit, contains:
2		hexagon bolt M8x45 (full thread)

Quant	item no.	description
4		filister head screw M8x30
8		hexagon bolt M6x16
2		self-lock nut M8
8		washer Ø8,4
8		washer Ø6,4
2		countersunk head screw M8x110 (full thread)



Control all screw connections after the assembling for tightness!
Please notice our enclosed service information.



Hepco & Becker GmbH
An der Steinmauer 6
D-66955 Pirmasens
Tel.: +49 6331 - 1453 - 100
Fax: +49 6331 - 1453 - 120
eMail: vertrieb@hepco-becker.de
www.hepco-becker.de

C-Bow Soft bag holder

HONDA CBR 250 R
(2011-)

Item-no.:
630966 00 01 black

HONDA CBR 300 R

Item-no.:
630991 00 01 black



Assembling instructions

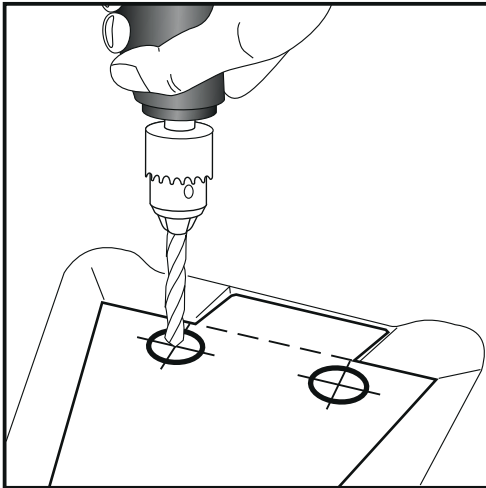

1

Preparing:

Dismantle:

- Pillion seat
- Footrest bracket (Original screws are obsolete)
- Fender cover under the seat

Drilling holes for fastening the rear adapter:

Cut out the drilling-pattern and put it on the inner side of the fender cover.

Drill out the marked points with $\varnothing 25$ mm.

Mount fender cover again.

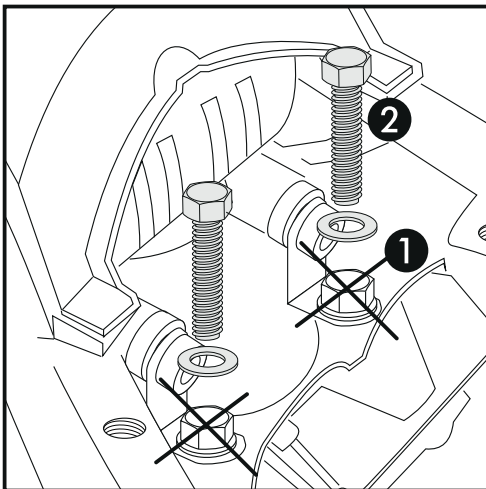

2

Fastening of the rear adapter:
under the fender.

Dismantle the two screws of the frame bolting - they are obsolete. To reach the screws it is necessary to dismantle the handle bars.

Change original screws with hexagon bolts M8x45 with washers $\varnothing 8,4$.

With the additional installation of a Alurack, the hexagon bolts M8x45 will be replaced with a countersunk head allen screw M8x110 with continuous thread - refer to the assembling instruction of the rack.

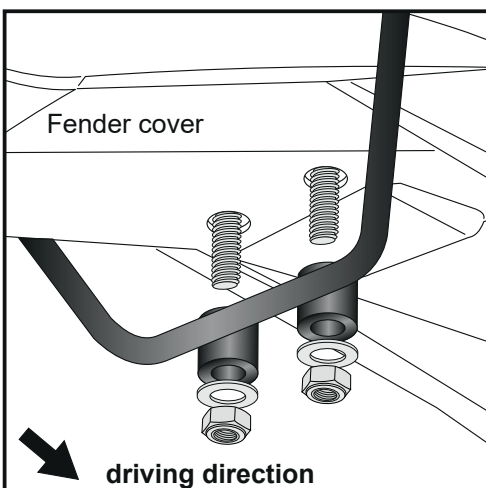
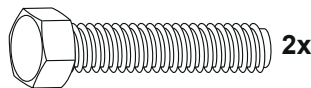

3

Fastening of the rear adapter:

at the threads of the hexagon bolts M8x45 under the fender cover with self lock nuts M8 and washers $\varnothing 8,4$.

Fix handle bars again.



C-Bow Soft bag holder

HONDA CBR 250 R
(2011-)

Item-no.:
630966 00 01 black

HONDA CBR 300 R

Item-no.:
630991 00 01 black



Assembling instructions

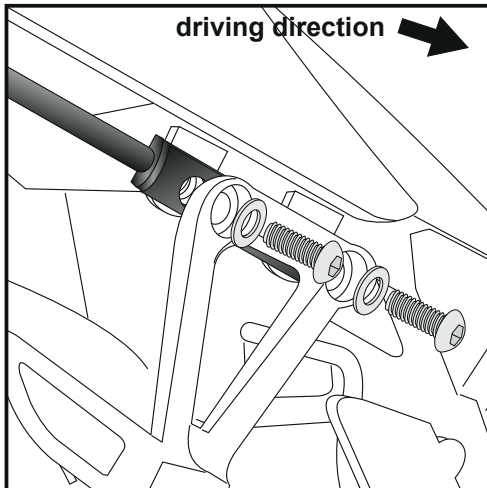

4

Fastening of the adapters left + right:
with filister head screws M8x30 and washers $\varnothing 8,4$ between the
footrest bracket and the frame.

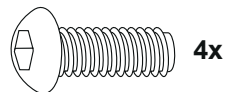

Fastening of the C-Bow:

For fastening, use hexagon bolts
M6 x 16 with washers $\varnothing 6,4$.

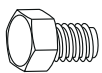

8x

8x



5

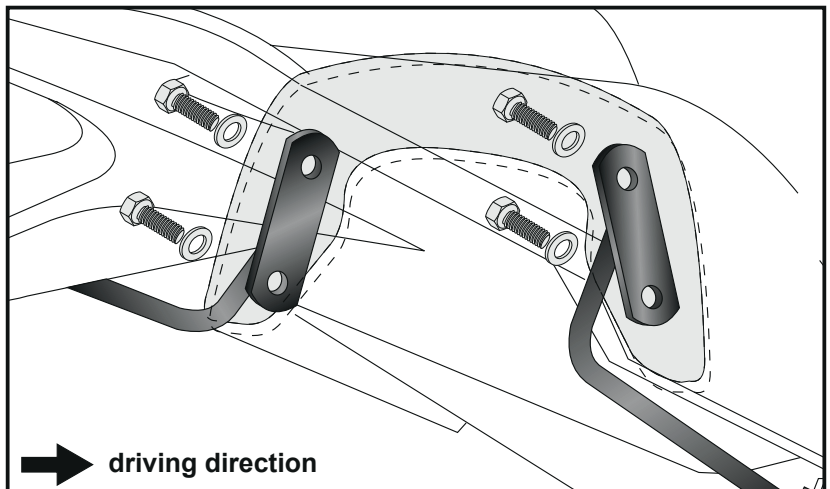

C-Bow

HONDA CBR 250 R

HONDA CBR 300 R

Bohrschablone

Drilling pattern

